

# MC33078, MC33079

## Low Noise Dual/Quad Operational Amplifiers

The MC33078/9 series is a family of high quality monolithic amplifiers employing Bipolar technology with innovative high performance concepts for quality audio and data signal processing applications. This family incorporates the use of high frequency PNP input transistors to produce amplifiers exhibiting low input voltage noise with high gain bandwidth product and slew rate. The all NPN output stage exhibits no deadband crossover distortion, large output voltage swing, excellent phase and gain margins, low open loop high frequency output impedance and symmetrical source and sink AC frequency performance.

The MC33078/9 family offers both dual and quad amplifier versions and is available in the plastic DIP and SOIC packages (P and D suffixes).

### Features

- Dual Supply Operation:  $\pm 5.0\text{ V}$  to  $\pm 18\text{ V}$
- Low Voltage Noise:  $4.5\text{ nV}/\sqrt{\text{Hz}}$
- Low Input Offset Voltage:  $0.15\text{ mV}$
- Low T.C. of Input Offset Voltage:  $2.0\text{ }\mu\text{V}/^\circ\text{C}$
- Low Total Harmonic Distortion:  $0.002\%$
- High Gain Bandwidth Product:  $16\text{ MHz}$
- High Slew Rate:  $7.0\text{ V}/\mu\text{s}$
- High Open Loop AC Gain:  $800 @ 20\text{ kHz}$
- Excellent Frequency Stability
- Large Output Voltage Swing:  $+14.1\text{ V}/-14.6\text{ V}$
- ESD Diodes Provided on the Inputs
- Pb-Free Packages are Available

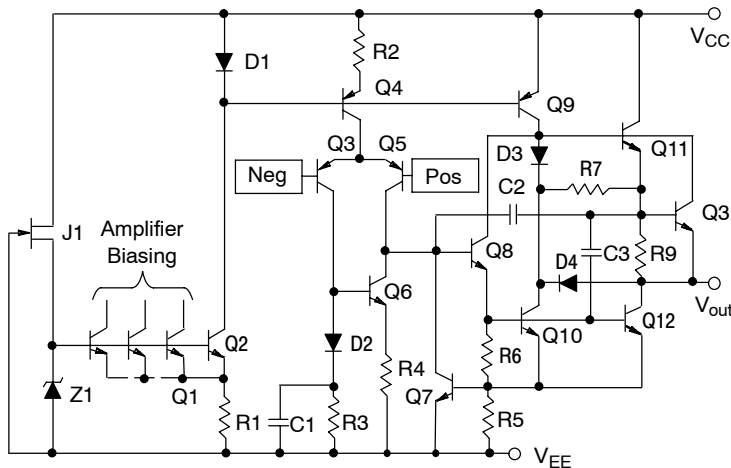


Figure 1. Representative Schematic Diagram  
(Each Amplifier)

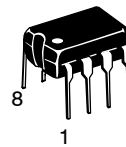


ON Semiconductor®

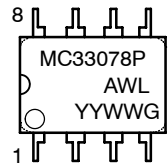
<http://onsemi.com>

### MARKING DIAGRAMS

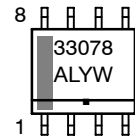
#### DUAL



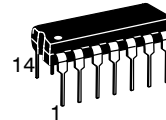
PDIP-8  
P SUFFIX  
CASE 626



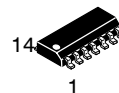
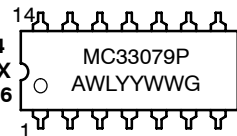
SOIC-8  
D SUFFIX  
CASE 751



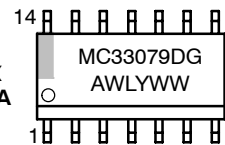
#### QUAD



PDIP-14  
P SUFFIX  
CASE 646



SOIC-14  
D SUFFIX  
CASE 751A



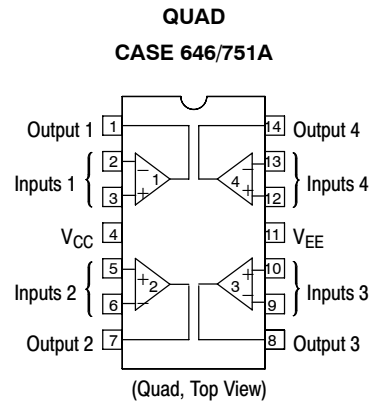
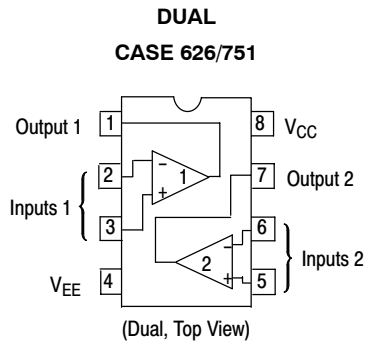
A = Assembly Location  
WL, L = Wafer Lot  
YY, Y = Year  
WW, W = Work Week  
G or ■ = Pb-Free Package

### ORDERING INFORMATION

See detailed ordering and shipping information in the package dimensions section on page 10 of this data sheet.

# MC33078, MC33079

## PIN CONNECTIONS



### MAXIMUM RATINGS

Rating	Symbol	Value	Unit	
Supply Voltage ( $V_{CC}$ to $V_{EE}$ )	$V_S$	+36	V	
Input Differential Voltage Range	$V_{IDR}$	Note 1	V	
Input Voltage Range	$V_{IR}$	Note 1	V	
Output Short Circuit Duration (Note 2)	$t_{SC}$	Indefinite	sec	
Maximum Junction Temperature	$T_J$	+150	°C	
Storage Temperature	$T_{stg}$	-60 to +150	°C	
ESD Protection at any Pin	$V_{esd}$	600 200 550 150	V	
MC33078				- Human Body Model
				- Machine Model
MC33079				- Human Body Model
		- Machine Model		
Maximum Power Dissipation	$P_D$	Note 2	mW	
Operating Temperature Range	$T_A$	-40 to +85	°C	

Stresses exceeding Maximum Ratings may damage the device. Maximum Ratings are stress ratings only. Functional operation above the Recommended Operating Conditions is not implied. Extended exposure to stresses above the Recommended Operating Conditions may affect device reliability.

1. Either or both input voltages must not exceed the magnitude of  $V_{CC}$  or  $V_{EE}$ .
2. Power dissipation must be considered to ensure maximum junction temperature ( $T_J$ ) is not exceeded (see Figure 2).

# MC33078, MC33079

## DC ELECTRICAL CHARACTERISTICS ( $V_{CC} = +15\text{ V}$ , $V_{EE} = -15\text{ V}$ , $T_A = 25^\circ\text{C}$ , unless otherwise noted.)

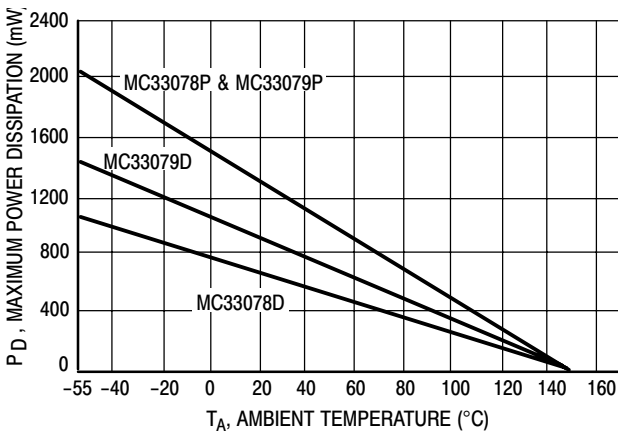
Characteristics	Symbol	Min	Typ	Max	Unit
Input Offset Voltage ( $R_S = 10\ \Omega$ , $V_{CM} = 0\text{ V}$ , $V_O = 0\text{ V}$ ) (MC33078) $T_A = +25^\circ\text{C}$ $T_A = -40^\circ$ to $+85^\circ\text{C}$ (MC33079) $T_A = +25^\circ\text{C}$ $T_A = -40^\circ$ to $+85^\circ\text{C}$	$ V_{IO} $	- - - -	0.15 - 0.15 -	2.0 3.0 2.5 3.5	mV
Average Temperature Coefficient of Input Offset Voltage $R_S = 10\ \Omega$ , $V_{CM} = 0\text{ V}$ , $V_O = 0\text{ V}$ , $T_A = T_{low}$ to $T_{high}$	$\Delta V_{IO}/\Delta T$	-	2.0	-	$\mu\text{V}/^\circ\text{C}$
Input Bias Current ( $V_{CM} = 0\text{ V}$ , $V_O = 0\text{ V}$ ) $T_A = +25^\circ\text{C}$ $T_A = -40^\circ$ to $+85^\circ\text{C}$	$I_{IB}$	- -	300 -	750 800	nA
Input Offset Current ( $V_{CM} = 0\text{ V}$ , $V_O = 0\text{ V}$ ) $T_A = +25^\circ\text{C}$ $T_A = -40^\circ$ to $+85^\circ\text{C}$	$I_{IO}$	- -	25 -	150 175	nA
Common Mode Input Voltage Range ( $\Delta V_{IO} = 5.0\text{ mV}$ , $V_O = 0\text{ V}$ )	$V_{ICR}$	$\pm 13$	$\pm 14$	-	V
Large Signal Voltage Gain ( $V_O = \pm 10\text{ V}$ , $R_L = 2.0\text{ k}\Omega$ ) $T_A = +25^\circ\text{C}$ $T_A = -40^\circ$ to $+85^\circ\text{C}$	$A_{VOL}$	90 85	110 -	- -	dB
Output Voltage Swing ( $V_{ID} = \pm 1.0\text{ V}$ ) $R_L = 600\ \Omega$ $R_L = 600\ \Omega$ $R_L = 2.0\text{ k}\Omega$ $R_L = 2.0\text{ k}\Omega$ $R_L = 10\text{ k}\Omega$ $R_L = 10\text{ k}\Omega$	$V_{O+}$ $V_{O-}$ $V_{O+}$ $V_{O-}$ $V_{O+}$ $V_{O-}$	- - +13.2 - +13.5 -	+10.7 -11.9 +13.8 -13.7 +14.1 -14.6	- - - -13.2 - -14	V
Common Mode Rejection ( $V_{in} = \pm 13\text{ V}$ )	CMR	80	100	-	dB
Power Supply Rejection (Note 3) $V_{CC}/V_{EE} = +15\text{ V}/-15\text{ V}$ to $+5.0\text{ V}/-5.0\text{ V}$	PSR	80	105	-	dB
Output Short Circuit Current ( $V_{ID} = 1.0\text{ V}$ , Output to Ground) Source Sink	$I_{SC}$	+15 -20	+29 -37	- -	mA
Power Supply Current ( $V_O = 0\text{ V}$ , All Amplifiers) (MC33078) $T_A = +25^\circ\text{C}$ $T_A = -40^\circ$ to $+85^\circ\text{C}$ (MC33079) $T_A = +25^\circ\text{C}$ $T_A = -40^\circ$ to $+85^\circ\text{C}$	$I_D$	- - - -	4.1 - 8.4 -	5.0 5.5 10 11	mA

3. Measured with  $V_{CC}$  and  $V_{EE}$  differentially varied simultaneously.

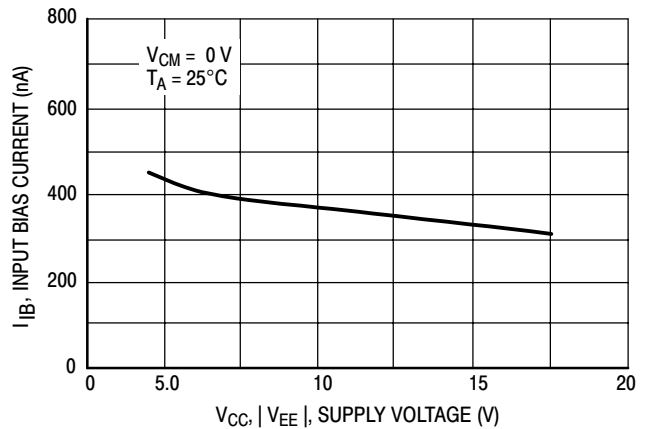
# MC33078, MC33079

**AC ELECTRICAL CHARACTERISTICS** ( $V_{CC} = +15\text{ V}$ ,  $V_{EE} = -15\text{ V}$ ,  $T_A = 25^\circ\text{C}$ , unless otherwise noted.)

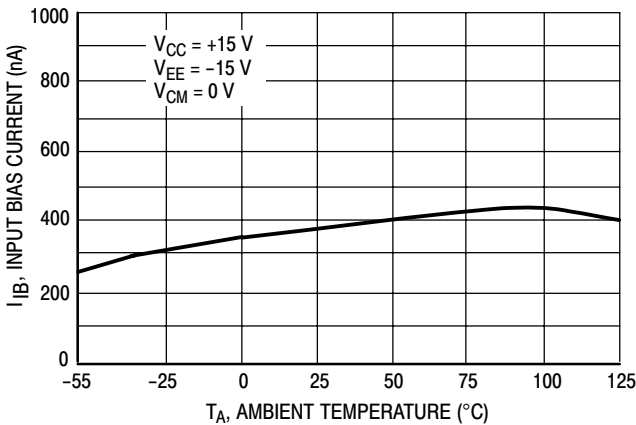
Characteristics	Symbol	Min	Typ	Max	Unit
Slew Rate ( $V_{in} = -10\text{ V}$ to $+10\text{ V}$ , $R_L = 2.0\text{ k}\Omega$ , $C_L = 100\text{ pF}$ , $A_V = +1.0$ )	SR	5.0	7.0	–	V/ $\mu\text{s}$
Gain Bandwidth Product ( $f = 100\text{ kHz}$ )	GBW	10	16	–	MHz
Unity Gain Bandwidth (Open Loop)	BW	–	9.0	–	MHz
Gain Margin ( $R_L = 2.0\text{ k}\Omega$ $C_L = 0\text{ pF}$ $C_L = 100\text{ pF}$ )	$A_m$	–	–11	–	dB
Phase Margin ( $R_L = 2.0\text{ k}\Omega$ $C_L = 0\text{ pF}$ $C_L = 100\text{ pF}$ )	$\phi_m$	–	55	–	Deg
Channel Separation ( $f = 20\text{ Hz}$ to $20\text{ kHz}$ )	CS	–	–120	–	dB
Power Bandwidth ( $V_O = 27\text{ V}_{pp}$ , $R_L = 2.0\text{ k}\Omega$ , THD $\pm 1.0\%$ )	$BW_p$	–	120	–	kHz
Total Harmonic Distortion ( $R_L = 2.0\text{ k}\Omega$ , $f = 20\text{ Hz}$ to $20\text{ kHz}$ , $V_O = 3.0\text{ V}_{rms}$ , $A_V = +1.0$ )	THD	–	0.002	–	%
Open Loop Output Impedance ( $V_O = 0\text{ V}$ , $f = 9.0\text{ MHz}$ )	$ Z_O $	–	37	–	$\Omega$
Differential Input Resistance ( $V_{CM} = 0\text{ V}$ )	$R_{in}$	–	175	–	$\text{k}\Omega$
Differential Input Capacitance ( $V_{CM} = 0\text{ V}$ )	$C_{in}$	–	12	–	pF
Equivalent Input Noise Voltage ( $R_S = 100\ \Omega$ , $f = 1.0\text{ kHz}$ )	$e_n$	–	4.5	–	$\text{nV}/\sqrt{\text{Hz}}$
Equivalent Input Noise Current ( $f = 1.0\text{ kHz}$ )	$i_n$	–	0.5	–	$\text{Hz}\sqrt{\text{pA}}$



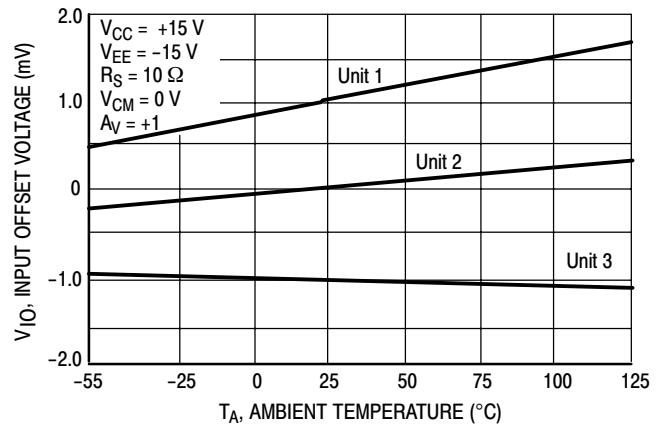
**Figure 2. Maximum Power Dissipation versus Temperature**



**Figure 3. Input Bias Current versus Supply Voltage**



**Figure 4. Input Bias Current versus Temperature**



**Figure 5. Input Offset Voltage versus Temperature**

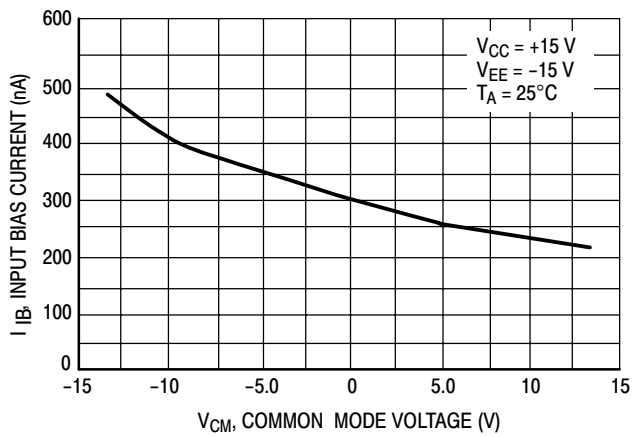


Figure 6. Input Bias Current versus Common Mode Voltage

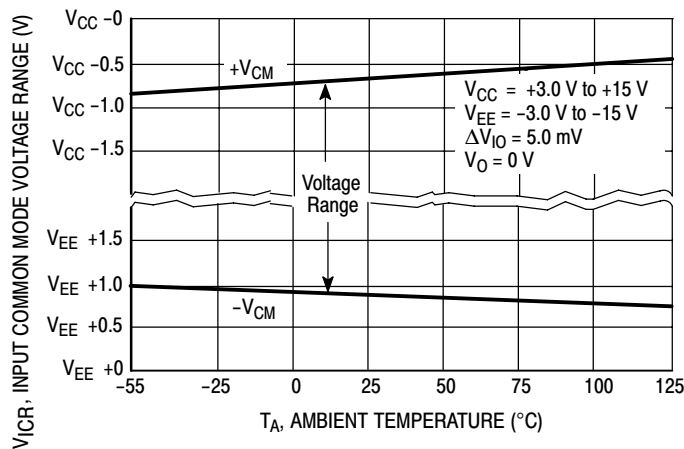


Figure 7. Input Common Mode Voltage Range versus Temperature

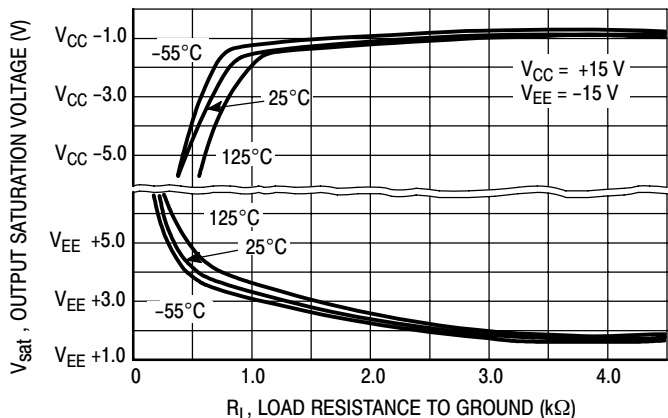


Figure 8. Output Saturation Voltage versus Load Resistance to Ground

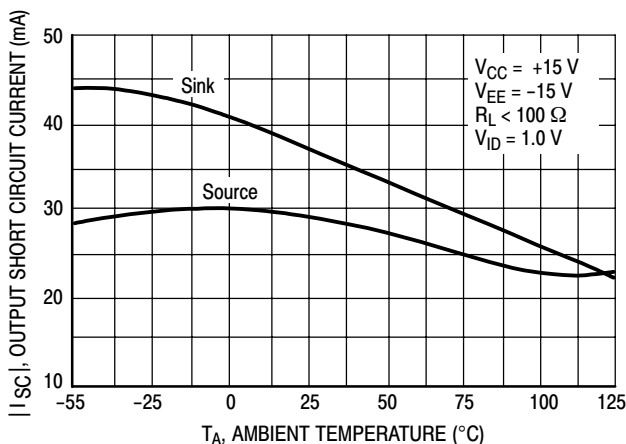


Figure 9. Output Short Circuit Current versus Temperature

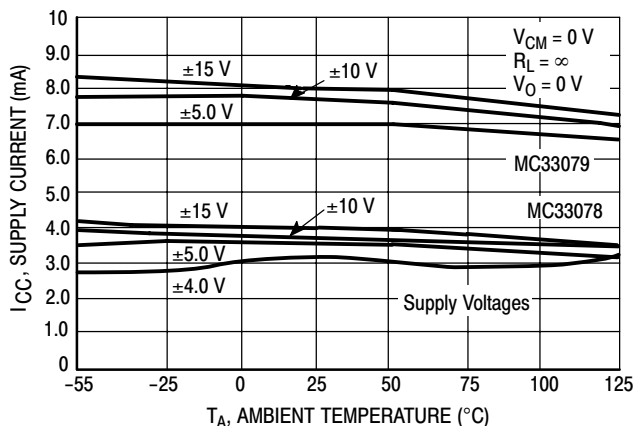


Figure 10. Supply Current versus Temperature

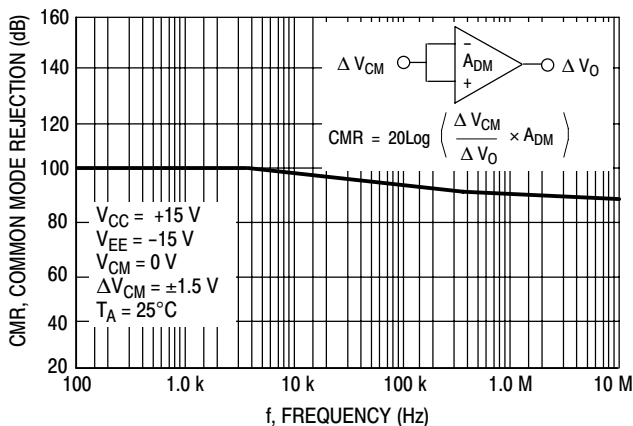
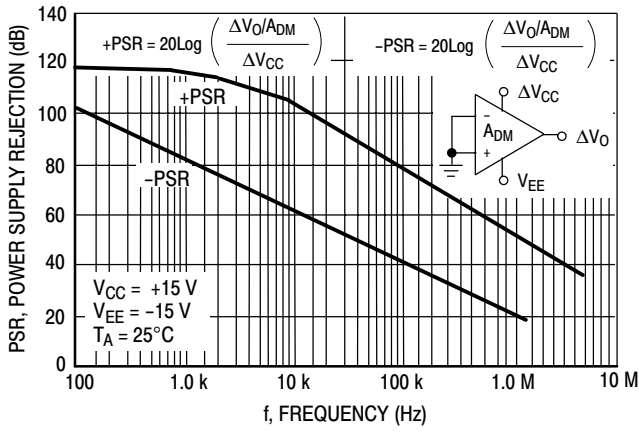
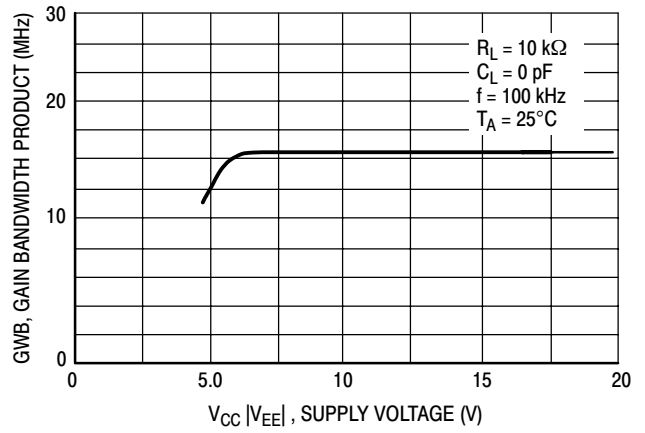


Figure 11. Common Mode Rejection versus Frequency

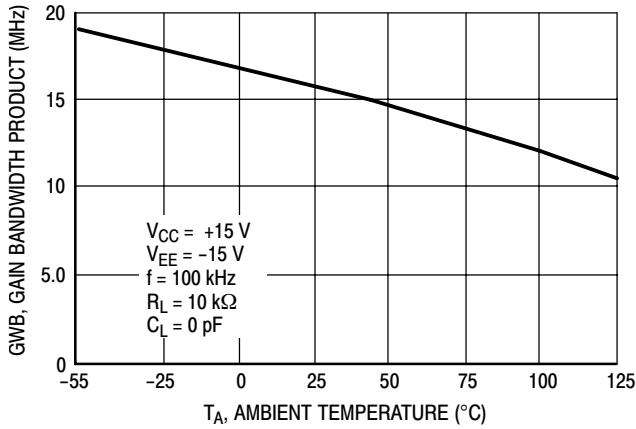
# MC33078, MC33079



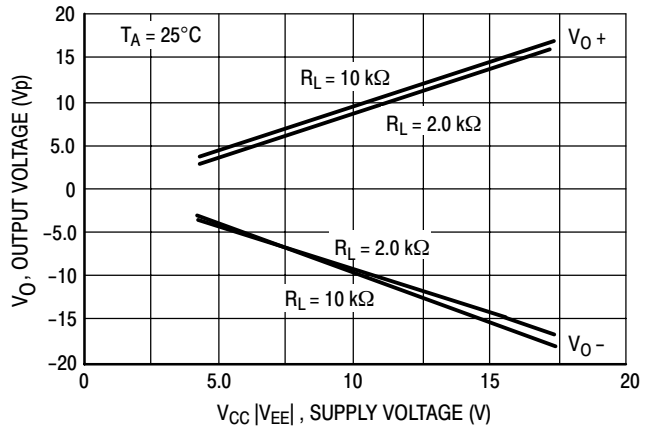
**Figure 12. Power Supply Rejection versus Frequency**



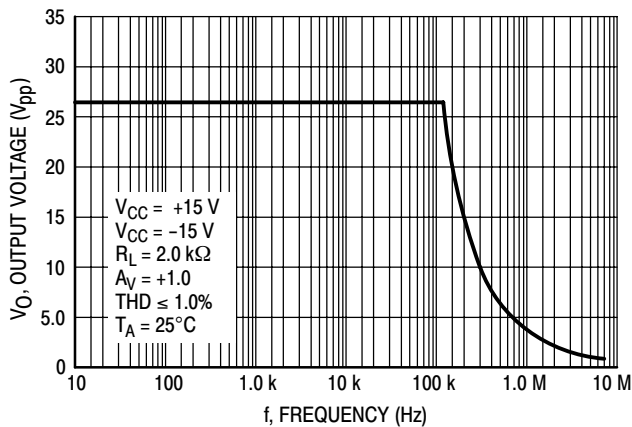
**Figure 13. Gain Bandwidth Product versus Supply Voltage**



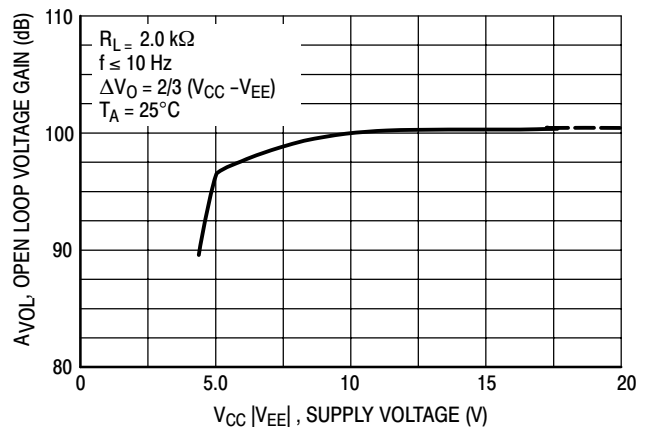
**Figure 14. Gain Bandwidth Product versus Temperature**



**Figure 15. Maximum Output Voltage versus Supply Voltage**

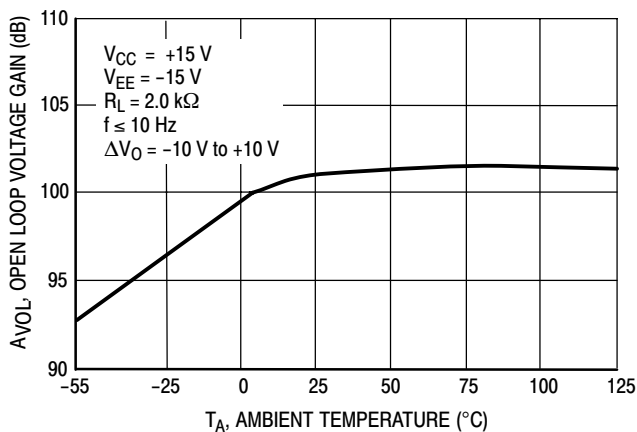


**Figure 16. Output Voltage versus Frequency**

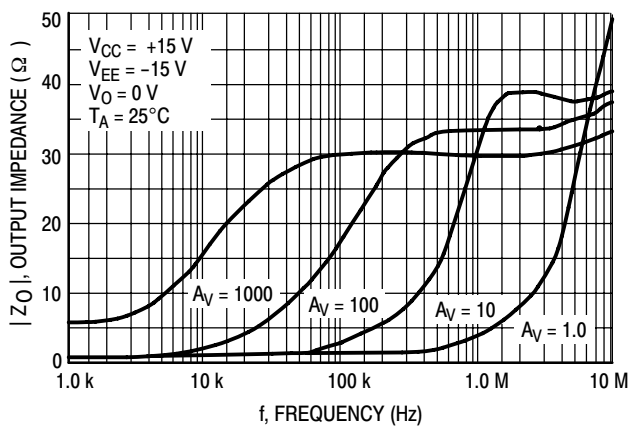


**Figure 17. Open Loop Voltage Gain versus Supply Voltage**

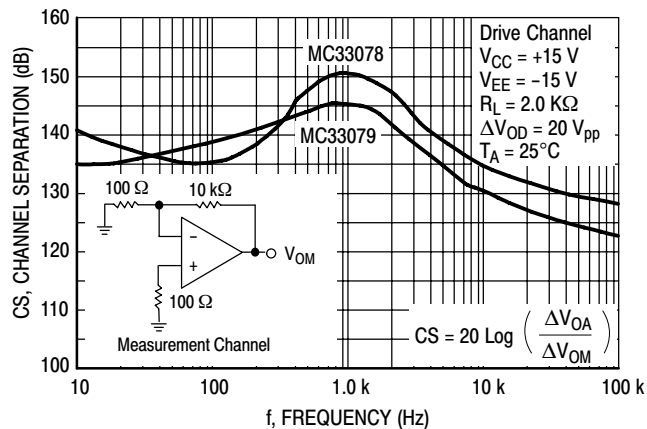
# MC33078, MC33079



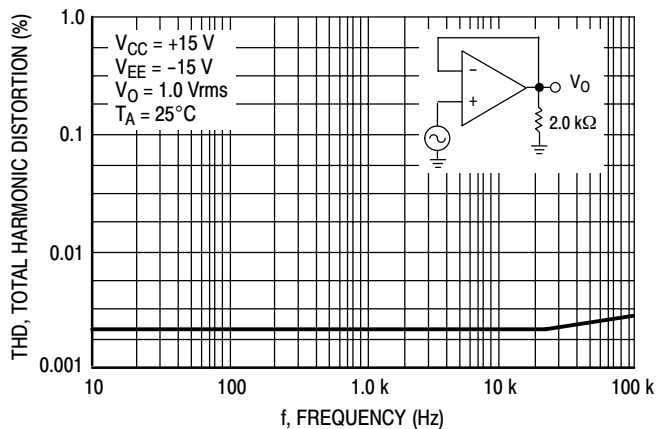
**Figure 18. Open Loop Voltage Gain versus Temperature**



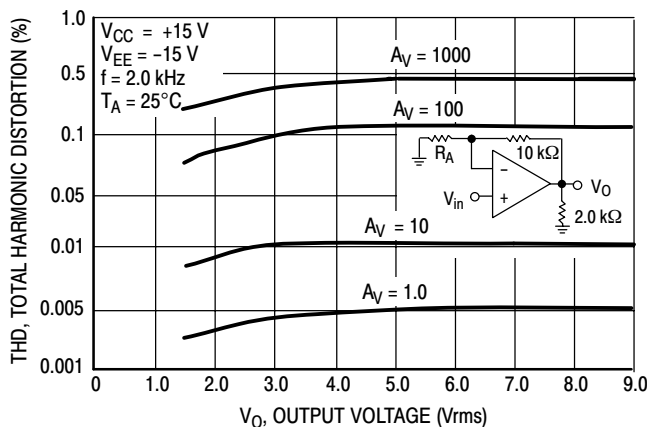
**Figure 19. Output Impedance versus Frequency**



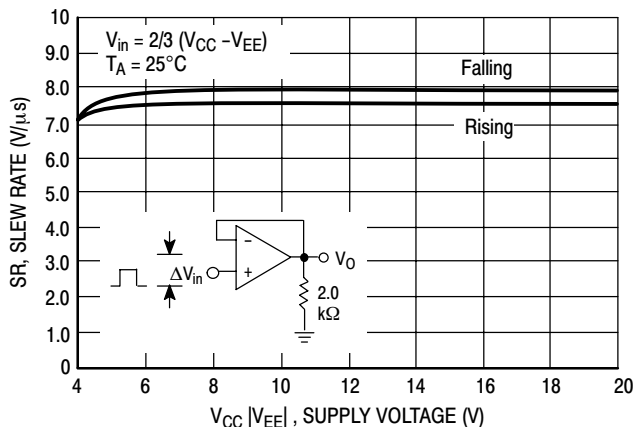
**Figure 20. Channel Separation versus Frequency**



**Figure 21. Total Harmonic Distortion versus Frequency**



**Figure 22. Total Harmonic Distortion versus Output Voltage**



**Figure 23. Slew Rate versus Supply Voltage**

# MC33078, MC33079

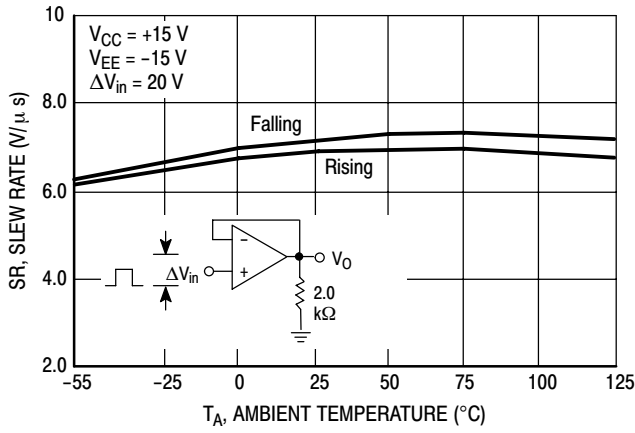


Figure 24. Slew Rate versus Temperature

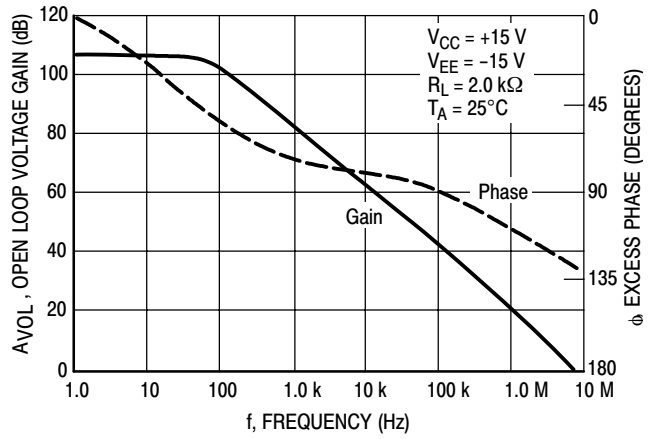


Figure 25. Voltage Gain and Phase versus Frequency

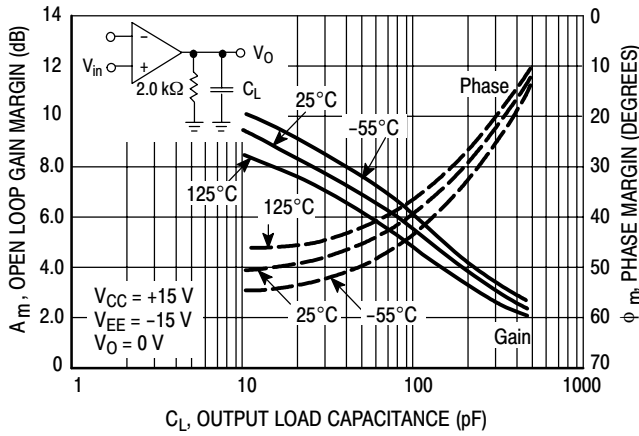


Figure 26. Open Loop Gain Margin and Phase Margin versus Load Capacitance

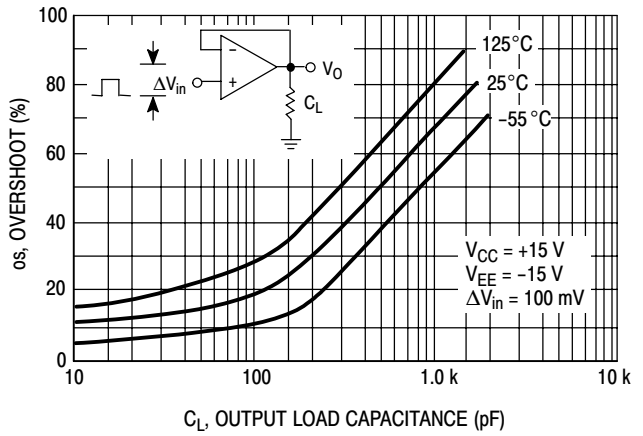


Figure 27. Overshoot versus Output Load Capacitance

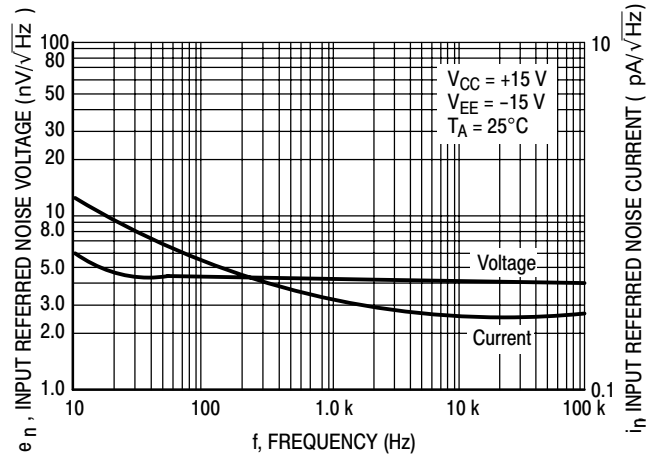


Figure 28. Input Referred Noise Voltage and Current versus Frequency

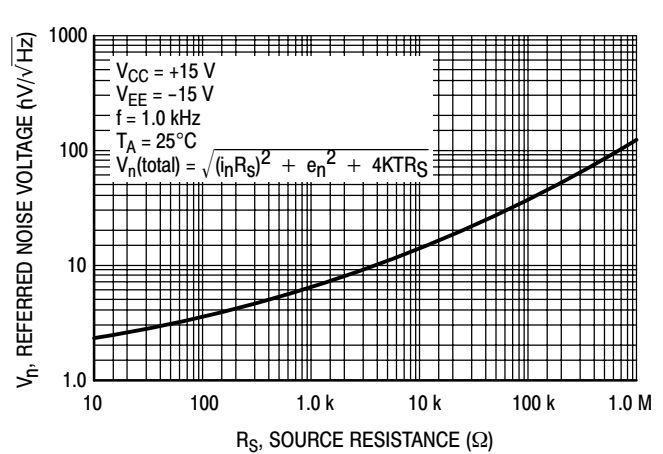
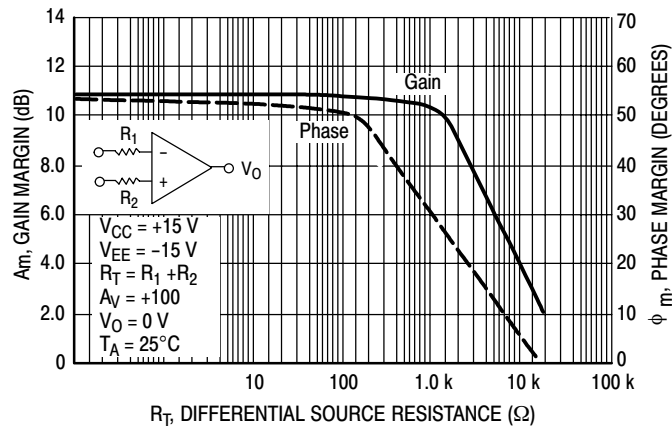


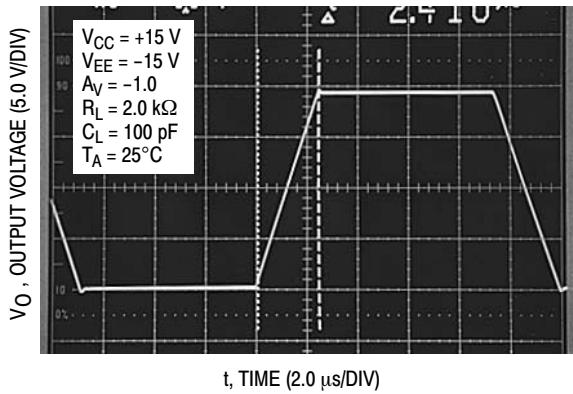
Figure 29. Total Input Referred Noise Voltage versus Source Resistance



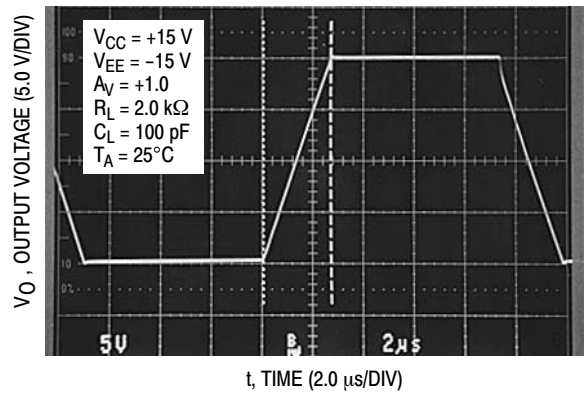
# MC33078, MC33079



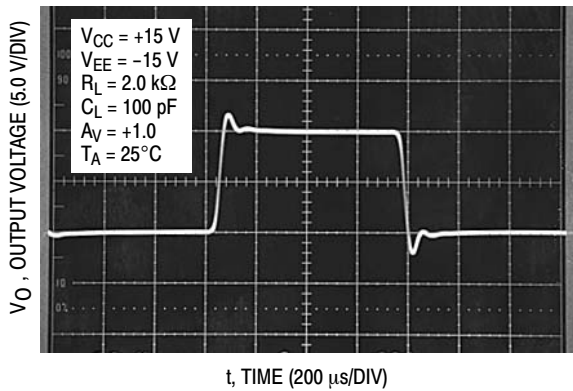
**Figure 30. Phase Margin and Gain Margin versus Differential Source Resistance**



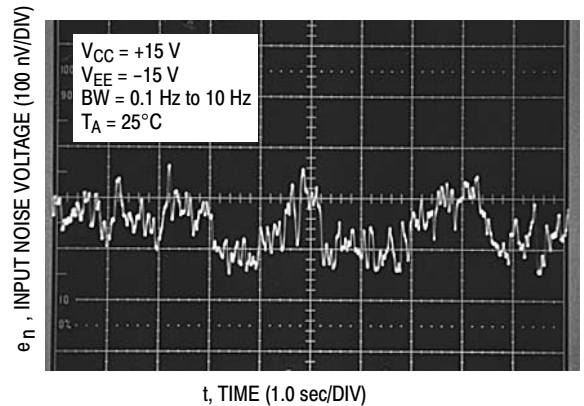
**Figure 31. Inverting Amplifier Slew Rate**



**Figure 32. Non-inverting Amplifier Slew Rate**

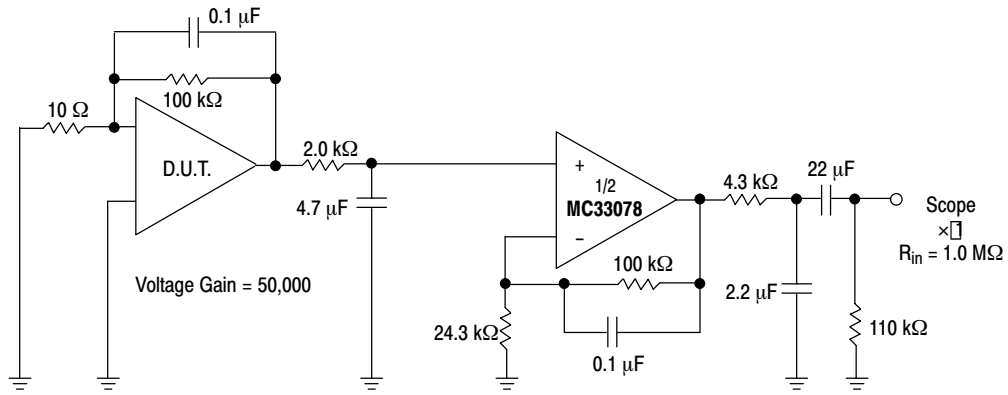


**Figure 33. Non-inverting Amplifier Overshoot**



**Figure 34. Low Frequency Noise Voltage versus Time**

## MC33078, MC33079



Note: All capacitors are non-polarized.

**Figure 35. Voltage Noise Test Circuit  
(0.1 Hz to 10 Hz<sub>p-p</sub>)**

### ORDERING INFORMATION

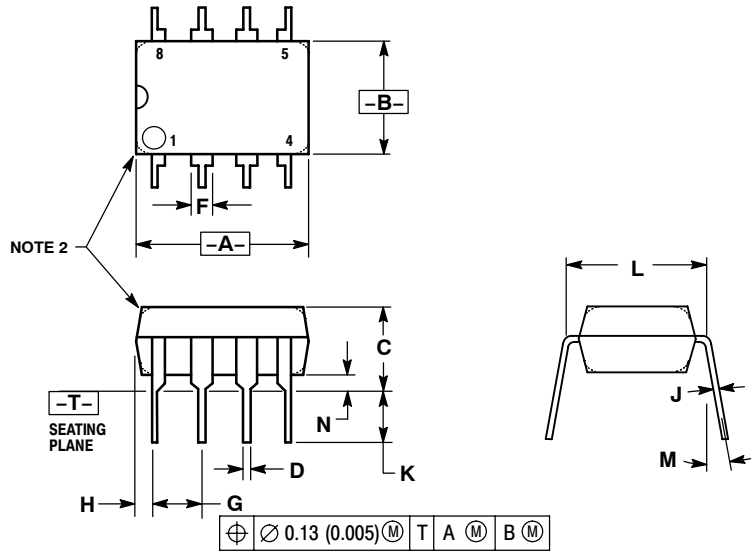
Device	Package	Shipping <sup>†</sup>
MC33078D	SOIC-8	98 Units / Rail
MC33078DG	SOIC-8 (Pb-Free)	
MC33078DR2	SOIC-8	2500 / Tape & Reel
MC33078DR2G	SOIC-8 (Pb-Free)	
MC33078P	PDIP-8	50 Units / Rail
MC33078PG	PDIP-8 (Pb-Free)	
MC33079D	SOIC-14	55 Units / Rail
MC33079DG	SOIC-14 (Pb-Free)	
MC33079DR2	SOIC-14	2500 / Tape & Reel
MC33079DR2G	SOIC-14 (Pb-Free)	
MC33079P	PDIP-14	25 Units / Rail
MC33079PG	PDIP-14 (Pb-Free)	

<sup>†</sup>For information on tape and reel specifications, including part orientation and tape sizes, please refer to our Tape and Reel Packaging Specifications Brochure, BRD8011/D.

# MC33078, MC33079

## PACKAGE DIMENSIONS

PDIP-8  
P SUFFIX  
CASE 626-05  
ISSUE L



NOTES:

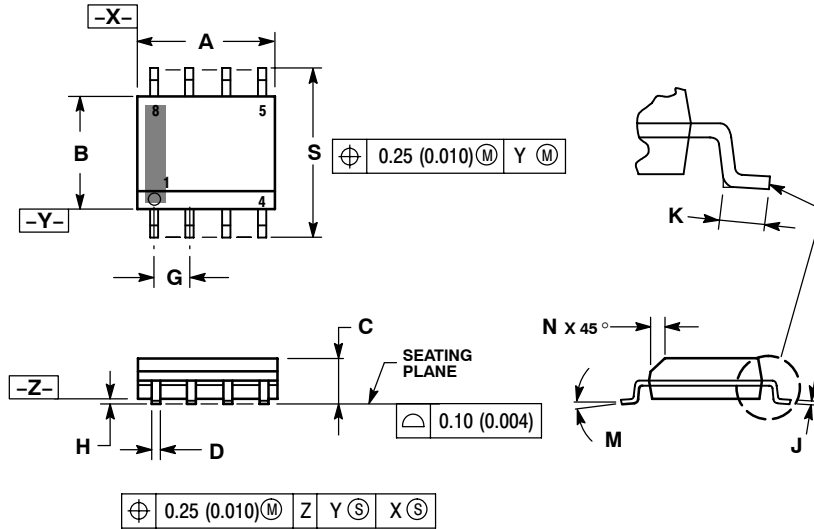
1. DIMENSION L TO CENTER OF LEAD WHEN FORMED PARALLEL.
2. PACKAGE CONTOUR OPTIONAL (ROUND OR SQUARE CORNERS).
3. DIMENSIONING AND TOLERANCING PER ANSI Y14.5M, 1982.

DIM	MILLIMETERS		INCHES	
	MIN	MAX	MIN	MAX
A	9.40	10.16	0.370	0.400
B	6.10	6.60	0.240	0.260
C	3.94	4.45	0.155	0.175
D	0.38	0.51	0.015	0.020
F	1.02	1.78	0.040	0.070
G	2.54 BSC		0.100 BSC	
H	0.76	1.27	0.030	0.050
J	0.20	0.30	0.008	0.012
K	2.92	3.43	0.115	0.135
L	7.62 BSC		0.300 BSC	
M	---	10 <sup>°</sup>	---	10 <sup>°</sup>
N	0.76	1.01	0.030	0.040

# MC33078, MC33079

## PACKAGE DIMENSIONS

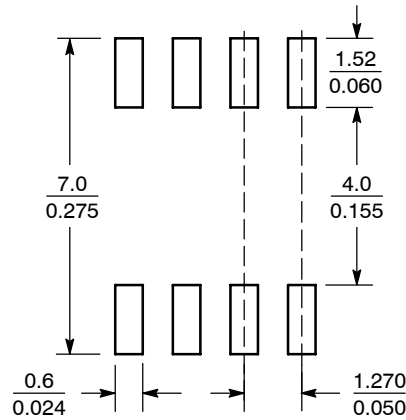
SOIC-8 NB  
CASE 751-07  
ISSUE AH



- NOTES:
1. DIMENSIONING AND TOLERANCING PER ANSI Y14.5M, 1982.
  2. CONTROLLING DIMENSION: MILLIMETER.
  3. DIMENSION A AND B DO NOT INCLUDE MOLD PROTRUSION.
  4. MAXIMUM MOLD PROTRUSION 0.15 (0.006) PER SIDE.
  5. DIMENSION D DOES NOT INCLUDE DAMBAR PROTRUSION. ALLOWABLE DAMBAR PROTRUSION SHALL BE 0.127 (0.005) TOTAL IN EXCESS OF THE D DIMENSION AT MAXIMUM MATERIAL CONDITION.
  6. 751-01 THRU 751-06 ARE OBSOLETE. NEW STANDARD IS 751-07.

DIM	MILLIMETERS		INCHES	
	MIN	MAX	MIN	MAX
A	4.80	5.00	0.189	0.197
B	3.80	4.00	0.150	0.157
C	1.35	1.75	0.053	0.069
D	0.33	0.51	0.013	0.020
G	1.27 BSC		0.050 BSC	
H	0.10	0.25	0.004	0.010
J	0.19	0.25	0.007	0.010
K	0.40	1.27	0.016	0.050
M	0°	8°	0°	8°
N	0.25	0.50	0.010	0.020
S	5.80	6.20	0.228	0.244

### SOLDERING FOOTPRINT\*



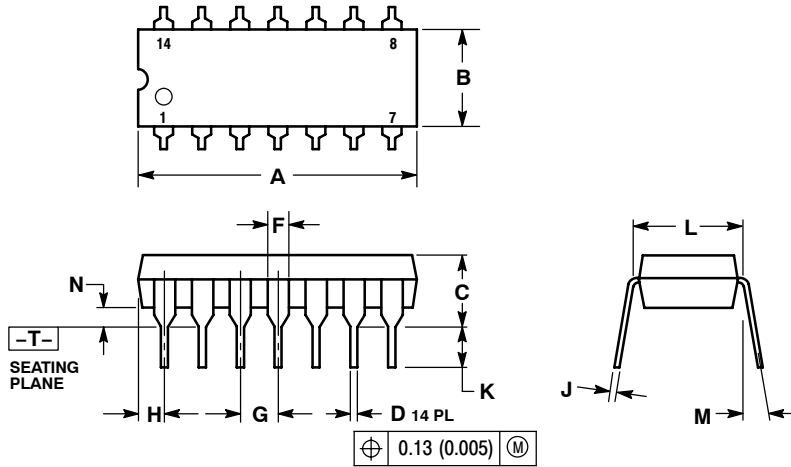
SCALE 6:1  $\left(\frac{\text{mm}}{\text{inches}}\right)$

\*For additional information on our Pb-Free strategy and soldering details, please download the ON Semiconductor Soldering and Mounting Techniques Reference Manual, SOLDERRM/D.

# MC33078, MC33079

## PACKAGE DIMENSIONS

**PDIP-14**  
CASE 646-06  
ISSUE P



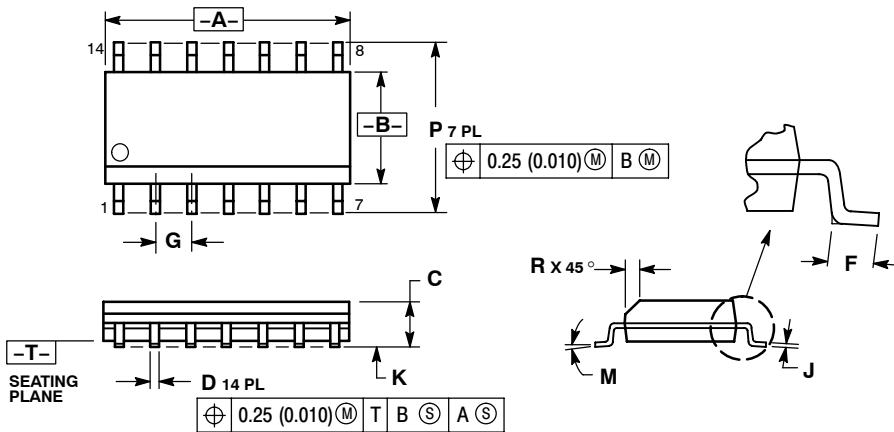
**NOTES:**

1. DIMENSIONING AND TOLERANCING PER ANSI Y14.5M, 1982.
2. CONTROLLING DIMENSION: INCH.
3. DIMENSION L TO CENTER OF LEADS WHEN FORMED PARALLEL.
4. DIMENSION B DOES NOT INCLUDE MOLD FLASH.
5. ROUNDED CORNERS OPTIONAL.

DIM	INCHES		MILLIMETERS	
	MIN	MAX	MIN	MAX
A	0.715	0.770	18.16	19.56
B	0.240	0.260	6.10	6.60
C	0.145	0.185	3.69	4.69
D	0.015	0.021	0.38	0.53
F	0.040	0.070	1.02	1.78
G	0.100 BSC		2.54 BSC	
H	0.052	0.095	1.32	2.41
J	0.008	0.015	0.20	0.38
K	0.115	0.135	2.92	3.43
L	0.290	0.310	7.37	7.87
M	--- 10°		--- 10°	
N	0.015	0.039	0.38	1.01

# MC33078, MC33079

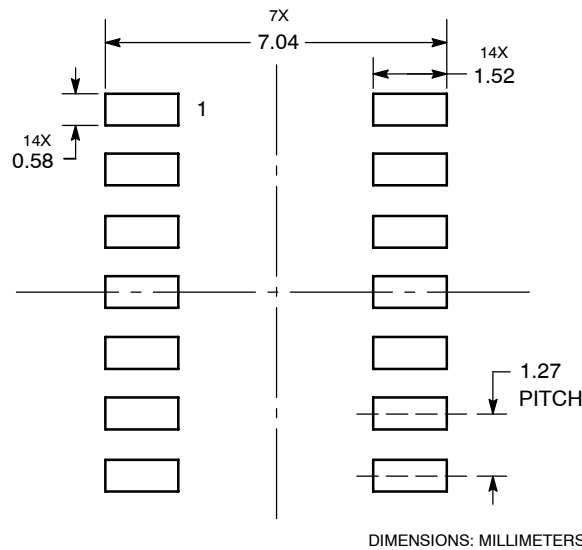
SOIC-14  
CASE 751A-03  
ISSUE H



- NOTES:
1. DIMENSIONING AND TOLERANCING PER ANSI Y14.5M, 1982.
  2. CONTROLLING DIMENSION: MILLIMETER.
  3. DIMENSIONS A AND B DO NOT INCLUDE MOLD PROTRUSION.
  4. MAXIMUM MOLD PROTRUSION 0.15 (0.006) PER SIDE.
  5. DIMENSION D DOES NOT INCLUDE DAMBAR PROTRUSION. ALLOWABLE DAMBAR PROTRUSION SHALL BE 0.127 (0.005) TOTAL IN EXCESS OF THE D DIMENSION AT MAXIMUM MATERIAL CONDITION.

MILLIMETERS		INCHES		
DIM	MIN	MAX	MIN	MAX
A	8.55	8.75	0.337	0.344
B	3.80	4.00	0.150	0.157
C	1.35	1.75	0.054	0.068
D	0.35	0.49	0.014	0.019
F	0.40	1.25	0.016	0.049
G	1.27 BSC		0.050 BSC	
J	0.19	0.25	0.008	0.009
K	0.10	0.25	0.004	0.009
M	0°	7°	0°	7°
P	5.80	6.20	0.228	0.244
R	0.25	0.50	0.010	0.019

## SOLDERING FOOTPRINT\*



DIMENSIONS: MILLIMETERS

\*For additional information on our Pb-Free strategy and soldering details, please download the ON Semiconductor Soldering and Mounting Techniques Reference Manual, SOLDERRM/D.

ON Semiconductor and are registered trademarks of Semiconductor Components Industries, LLC (SCILLC). SCILLC reserves the right to make changes without further notice to any products herein. SCILLC makes no warranty, representation or guarantee regarding the suitability of its products for any particular purpose, nor does SCILLC assume any liability arising out of the application or use of any product or circuit, and specifically disclaims any and all liability, including without limitation special, consequential or incidental damages. "Typical" parameters which may be provided in SCILLC data sheets and/or specifications can and do vary in different applications and actual performance may vary over time. All operating parameters, including "Typicals" must be validated for each customer application by customer's technical experts. SCILLC does not convey any license under its patent rights nor the rights of others. SCILLC products are not designed, intended, or authorized for use as components in systems intended for surgical implant into the body, or other applications intended to support or sustain life, or for any other application in which the failure of the SCILLC product could create a situation where personal injury or death may occur. Should Buyer purchase or use SCILLC products for any such unintended or unauthorized application, Buyer shall indemnify and hold SCILLC and its officers, employees, subsidiaries, affiliates, and distributors harmless against all claims, costs, damages, and expenses, and reasonable attorney fees arising out of, directly or indirectly, any claim of personal injury or death associated with such unintended or unauthorized use, even if such claim alleges that SCILLC was negligent regarding the design or manufacture of the part. SCILLC is an Equal Opportunity/Affirmative Action Employer. This literature is subject to all applicable copyright laws and is not for resale in any manner.

## PUBLICATION ORDERING INFORMATION

**LITERATURE FULFILLMENT:**  
Literature Distribution Center for ON Semiconductor  
P.O. Box 5163, Denver, Colorado 80217 USA  
**Phone:** 303-675-2175 or 800-344-3860 Toll Free USA/Canada  
**Fax:** 303-675-2176 or 800-344-3867 Toll Free USA/Canada  
**Email:** orderlit@onsemi.com

**N. American Technical Support:** 800-282-9855 Toll Free  
USA/Canada  
**Europe, Middle East and Africa Technical Support:**  
Phone: 421 33 790 2910  
**Japan Customer Focus Center**  
Phone: 81-3-5773-3850

**ON Semiconductor Website:** [www.onsemi.com](http://www.onsemi.com)  
**Order Literature:** <http://www.onsemi.com/orderlit>

For additional information, please contact your local Sales Representative